

• MALLY KONSTRUKTOR •  
• **CONSTRUCTOR** •

8+  
282

2850  
**PTERODACTYL**



# • MAŁY • KONSTRUKTOR • • CONSTRUCTOR •

**EN:** In case any of the elements listed in the contents is missing, please contact us at: / **BA:** Ukoliko sadržaj pakovanja ne odgovara listi delova, kontaktirajte nas na sledeću e-mail adresu: / **BG:** Ако съдържанието на опаковката не съответства на списъка с елементи, моля, свържете се с нас на този имейл адрес: / **CZ:** V případě nesouladu obsahu obalu se seznamem elementů prosíme o kontakt na adresu e-mail: / **DE:** Bei fehlenden Teilen helfen wir gerne weiter unter: / **DK:** Hvis indholdet ikke svarer til oversigt over elementer, kontakt os via e-mail: / **EE:** Tootmisprotsessist tulenevatel põhjustel võib toote elementide toon erineda pakendil näidatust: / **ES:** En caso de que falten elementos, por favor póngase en contacto con nosotros a través de/En cas que faltin elements, si us plau poseu-vos en contacte amb nosaltres a través de: / **FI:** Jos pakkauksen sisältö ei vastaa luetteloa, otathan meihin yhteyttä sähköpostitse: / **FR:** Si l'un des éléments venait à manquer, veuillez nous contacter: / **GR:** Εάν το περιεχόμενο της συσκευασίας δεν περιλαμβάνει όλα τα απαραίτητα στοιχεία, όπως αυτά παρουσιάζονται στον κατάλογο, παρακαλούμε επικοινωνήστε μαζί μας στην ακόλουθη διεύθυνση ηλεκτρονικού ταχυδρομείου: / **HR:** Ako sadržaj ambalaže ne odgovara popisu dijelova, kontaktirajte nas na sljedeću adresu e-pošte: / **HU:** Amennyiben a csomagolás tartalma eltér a tartalomlistával, kérjük írjon nekünk a következő e-mail címre: / **IT:** Se il contenuto della confezione non corrisponde all'elenco dei pezzi, vi preghiamo di contattarci via e-mail al seguente indirizzo: / **LT:** Pastebėjus detalių trūkumą, kreiptis: / **LV:** Ja iepakojuma saturs neatbilst elementu sarakstam, lūdzu, sazinieties ar mums, izmantojot šo e-pasta adresi: / **NL:** Er sommige in de inhoud vermeld onderdelen ontbreken neem dan contact met ons op via e-mail: / **NO:** Hvis innholdet i emballasjen ikke stemmer overens med listen over elementene, vennligst kontakt oss på følgende e-postadresse: / **PL:** W przypadku niezgodności zawartości opakowania ze spisem elementów prosimy o kontakt e-mail: / **PT:** Se o conteúdo da embalagem não corresponder à lista de elementos, entre em contato conosco através do seguinte endereço de e-mail: / **RO:** Dacă conținutul ambalajului nu corespunde listei de elemente, vă rugăm să ne contactați la următoarea adresă de e-mail: / **RS:** Ako sadržaj paketa ne odgovara listi elemenata, kontaktirajte nas na sledeću adresu e-pošte: / **SE:** Om någon del i innehållet saknas, vänligen kontakta oss på: / **SI:** Če se vsebina v embalaži ne bi ujemala s seznamom elementov, prosimo, da nas kontaktirate z uporabo tega e-poštnega naslova: / **SK:** V prípade nesúlady obsahu obalu so zoznamom elementov prosíme o kontakt na adresu e-mail:

[help@alexander.com.pl](mailto:help@alexander.com.pl)



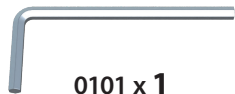

0101 x 1



0102 x 1



1006 x 71



1007 x 63

M4 - 6mm



1001 x 25

M4 - 10mm



1002 x 4

M4 - 12mm



1003 x 6

M4 - 16mm



1004 x 4

M4 - 20mm



1005 x 4

M4 - 30mm



1008 x 2



04K1 x 2



033C x 1



033FF x 4



0209 x 2

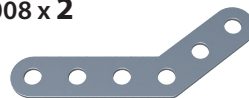

0216 x 10



035C x 1



037C x 1



021F x 2



0604 x 6



0602 x 19



0603 x 12



0615 x 8



035B x 1



0781Z x 10



0781CZ x 4



0783 x 8



0782F x 12

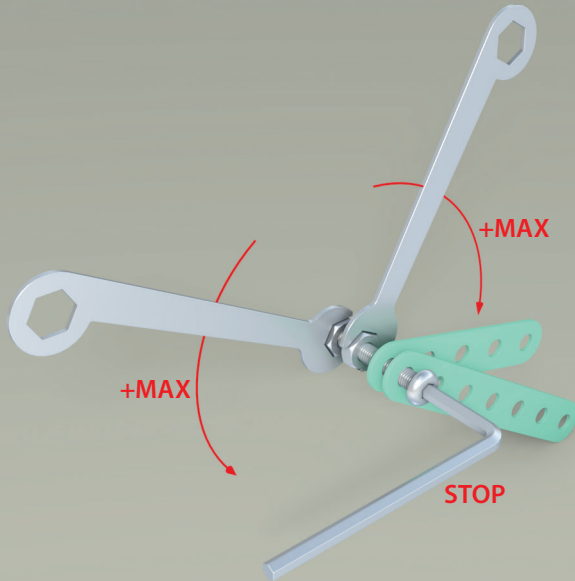

-  x 3
-  x 2
-  x 2
-  x 2
-  x 2
-  x 2





1004

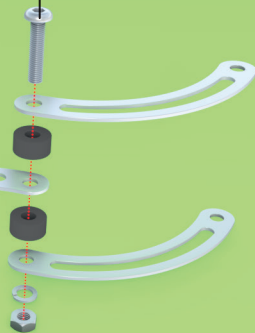

1004





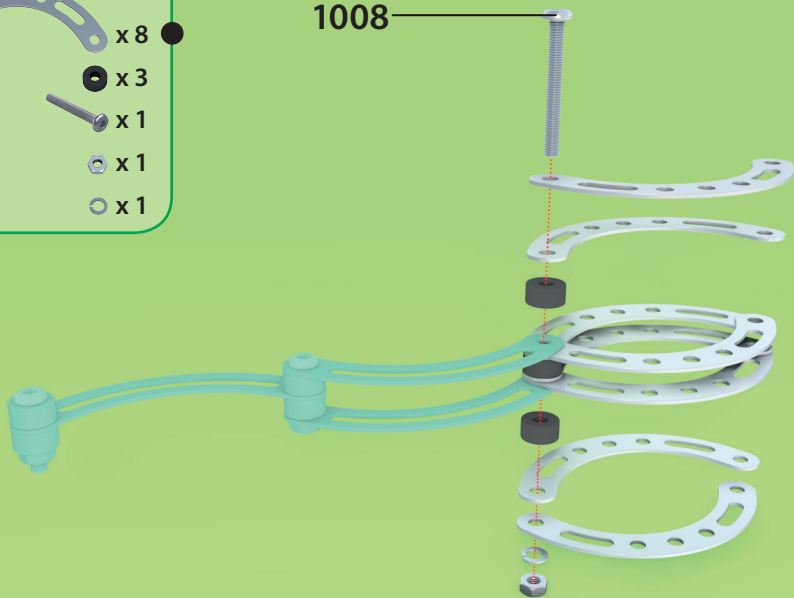

1

-  x 8
-  x 3
-  x 1
-  x 1
-  x 1

1008





2

-  x 2
-  x 3
-  x 1
-  x 1
-  x 1

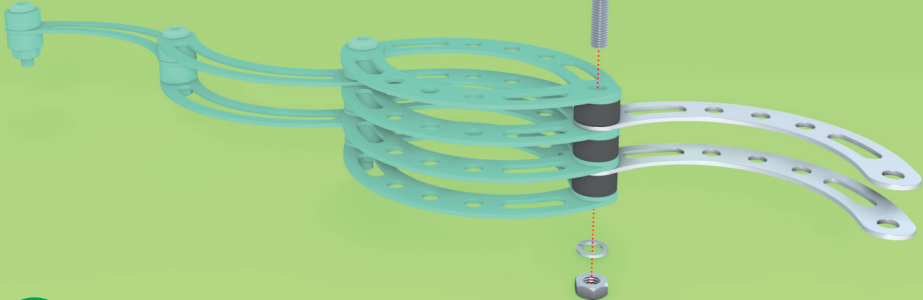
1008



3

-  x 4 ●
-  x 1 ●
-  x 1
-  x 4
-  x 4
-  x 4

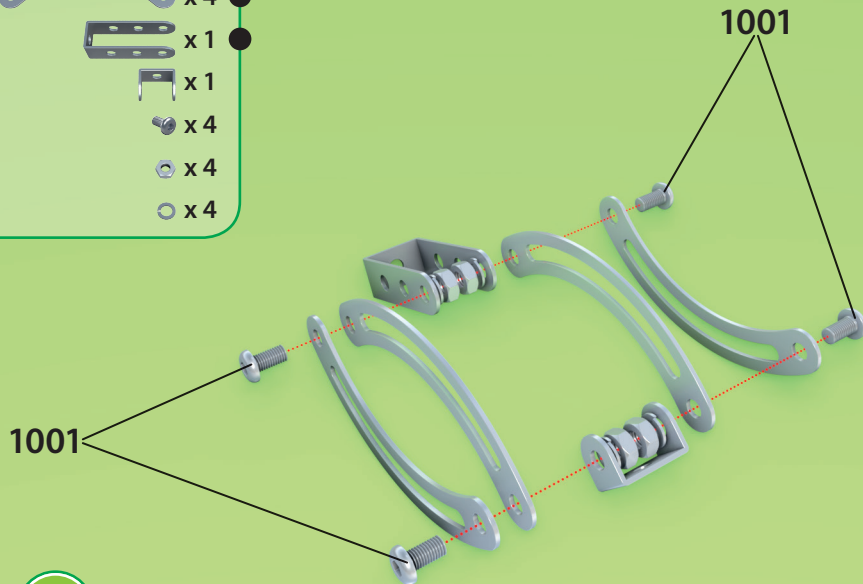

4

-  x 2
-  x 2
-  x 2
-  x 2
-  x 2
-  x 2

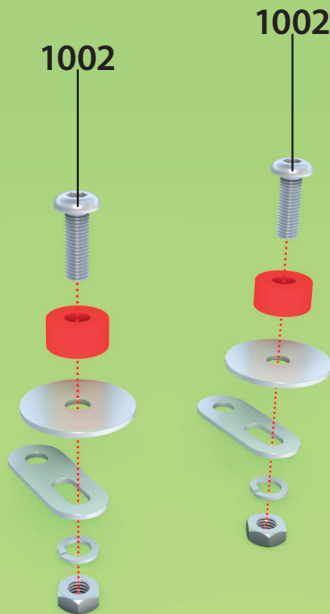

 x 2

 x 2





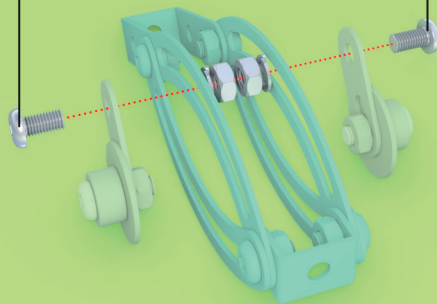

 x 2

1001

1001



6

-  x 1 
-  x 1 
-  x 1
-  x 1
-  x 1

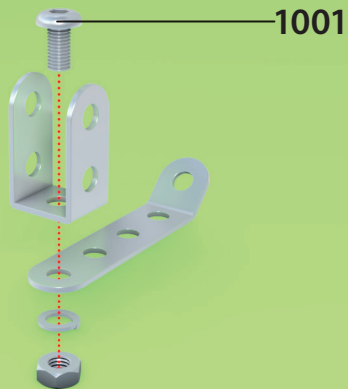

 x 3

 x 1

 x 1

 x 1

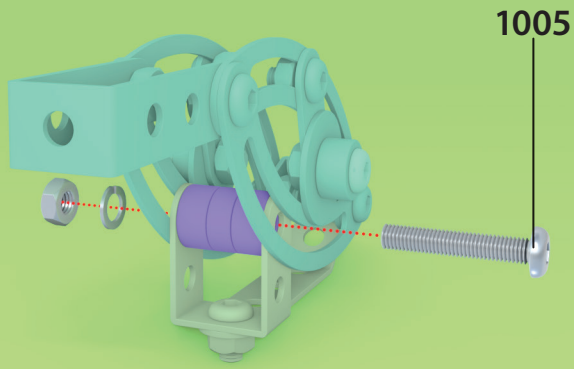





 x 3

 x 1

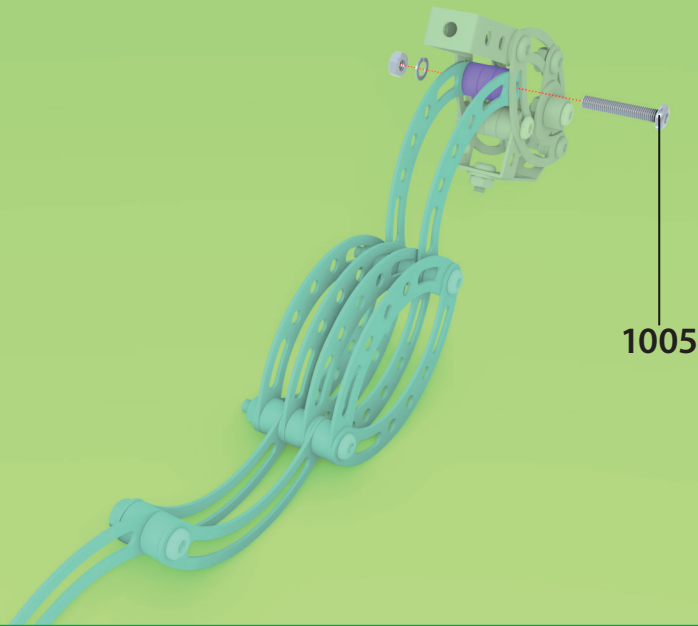
 x 1

 x 1



-  x 2
-  x 4
-  x 4
-  x 4

1001



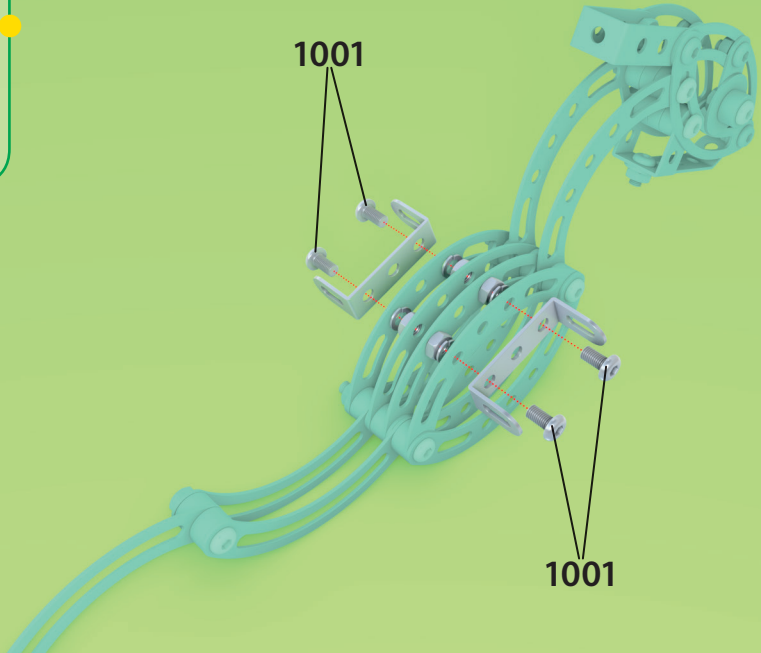

1001

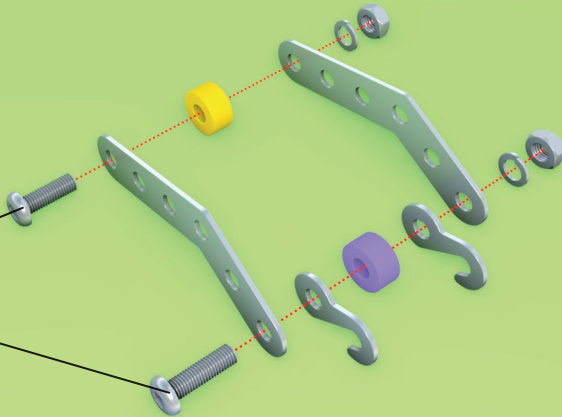

-  x 2
-  x 2
-  x 1
-  x 1
-  x 2
-  x 2
-  x 2





1002

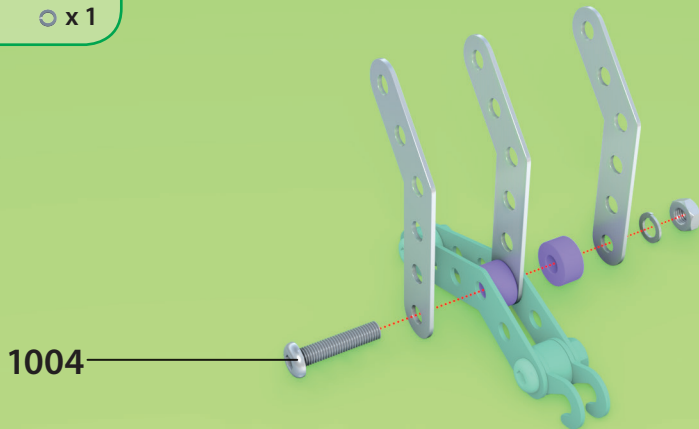

-  x 2
-  x 3
-  x 1
-  x 1
-  x 1





-  x 2
-  x 3
-  x 1
-  x 1
-  x 1

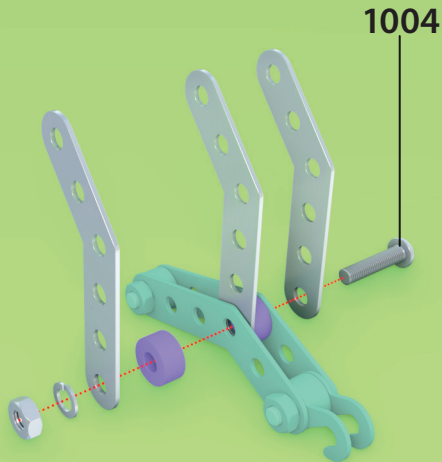

 x 2

 x 1

 x 2

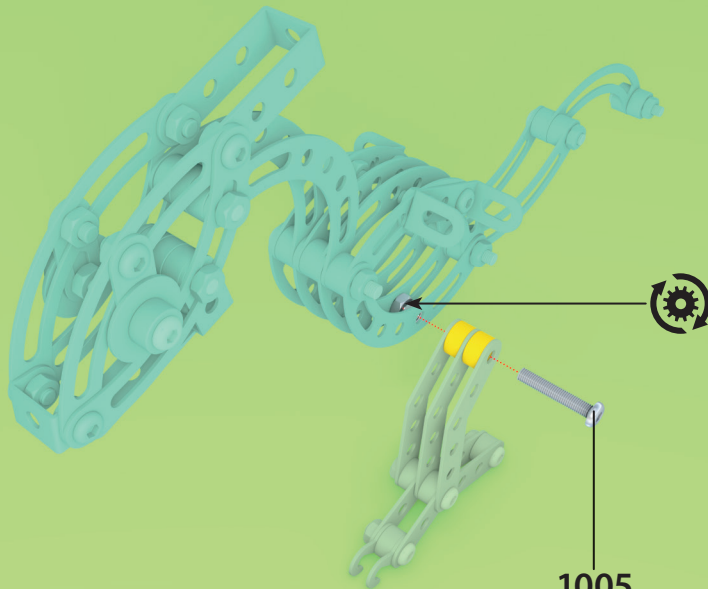

15

1005



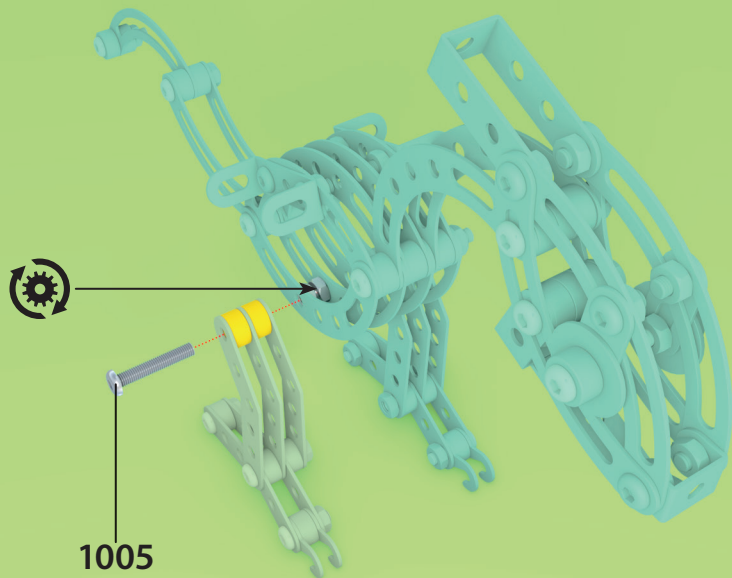

 x 2

 x 1







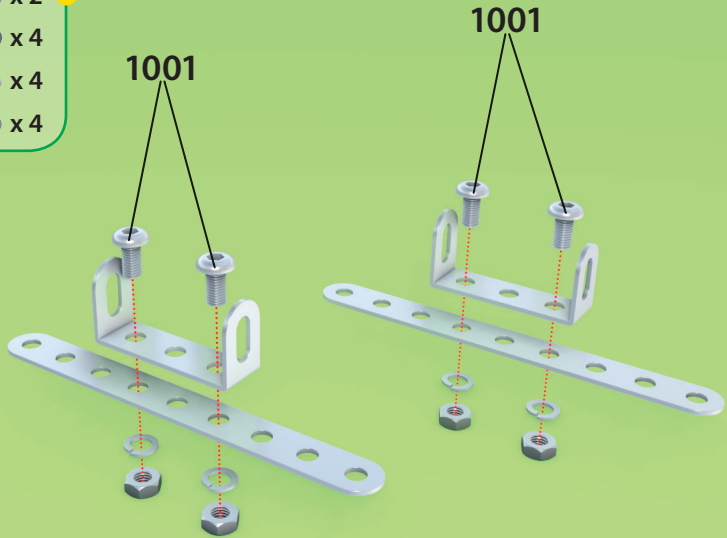

 x 2





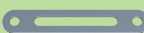





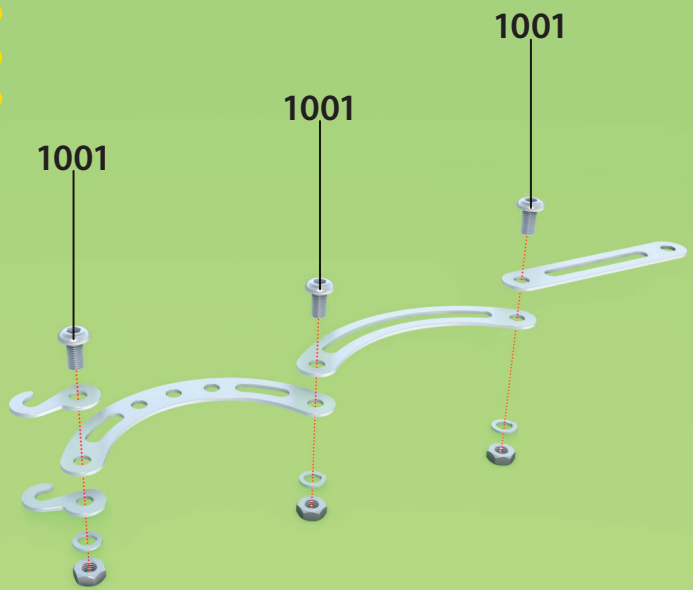

1005

-  x 2
-  x 2
-  x 4
-  x 4
-  x 4

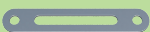

-  x1 
-  x1 
-  x1 
-  x2
-  x3
-  x3
-  x3



-  x1 
-  x1 
-  x1 
-  x2
-  x3
-  x3
-  x3

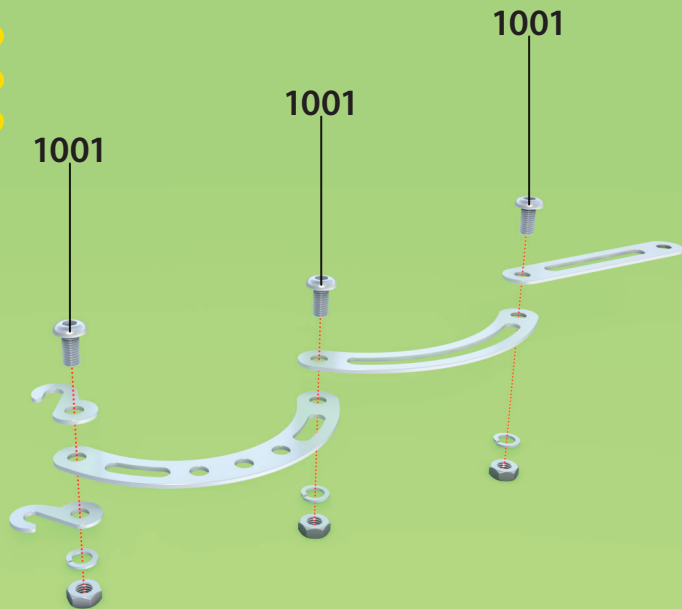

 x 1

 x 1

 x 1

1001

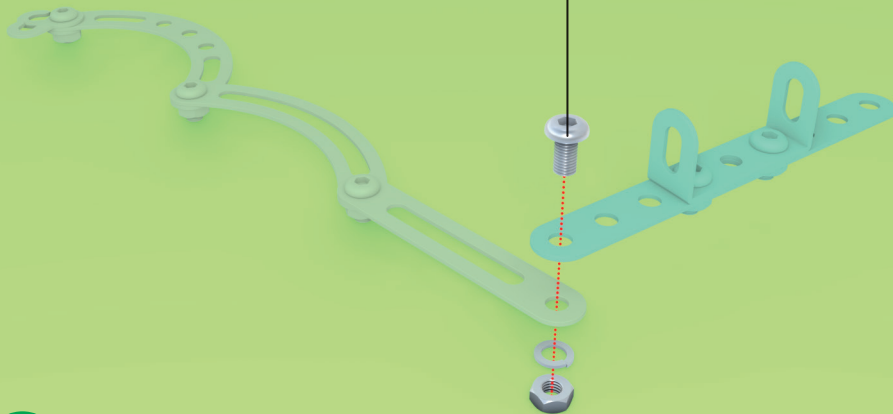

20

 x 1



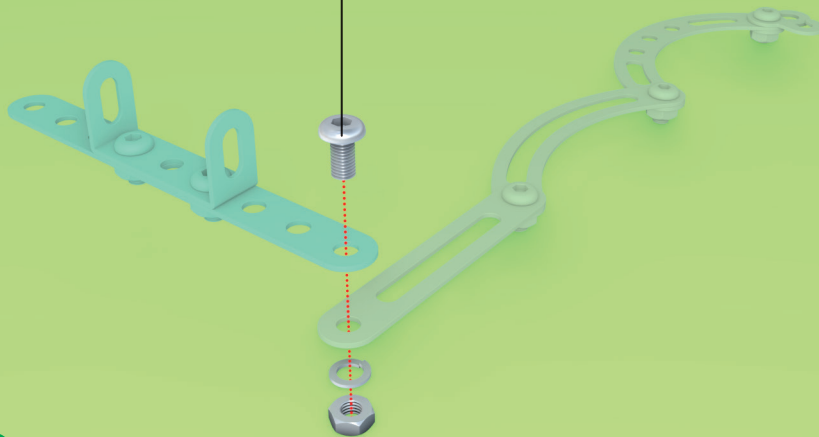

 x 1

 x 1

1001



21

-  x 6
-  x 6
-  x 6
-  x 6

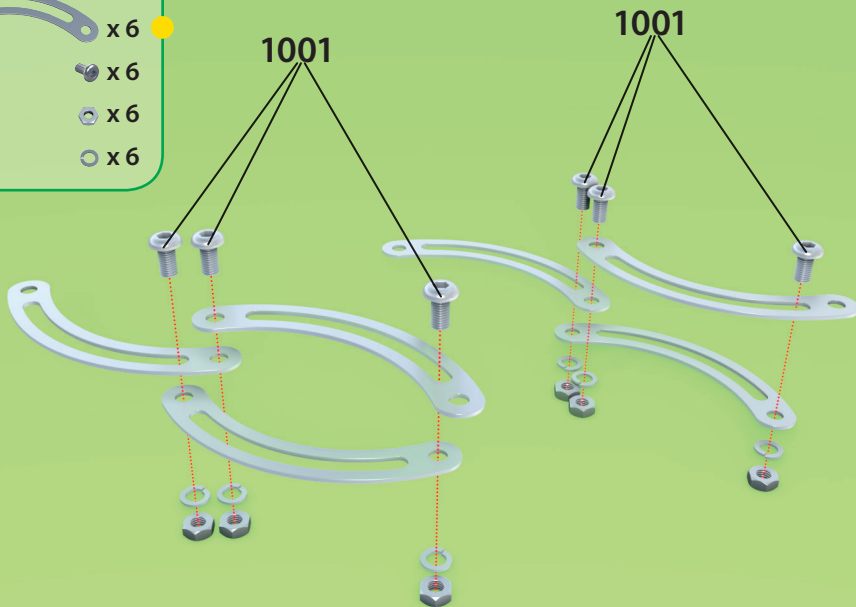

 x 2

 x 2

 x 2

1001

1001

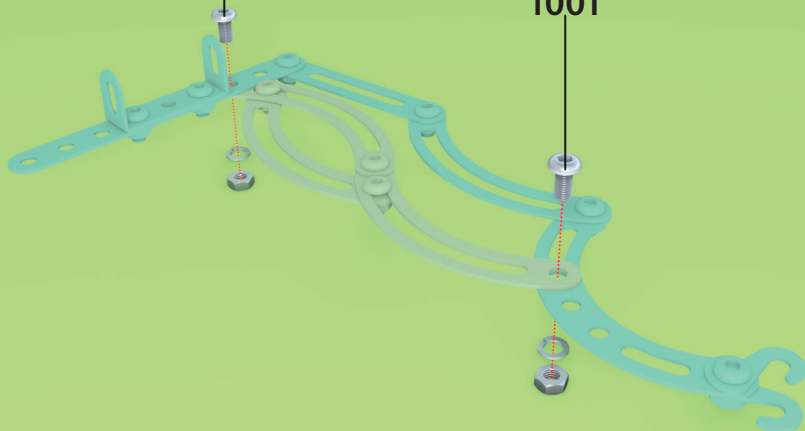





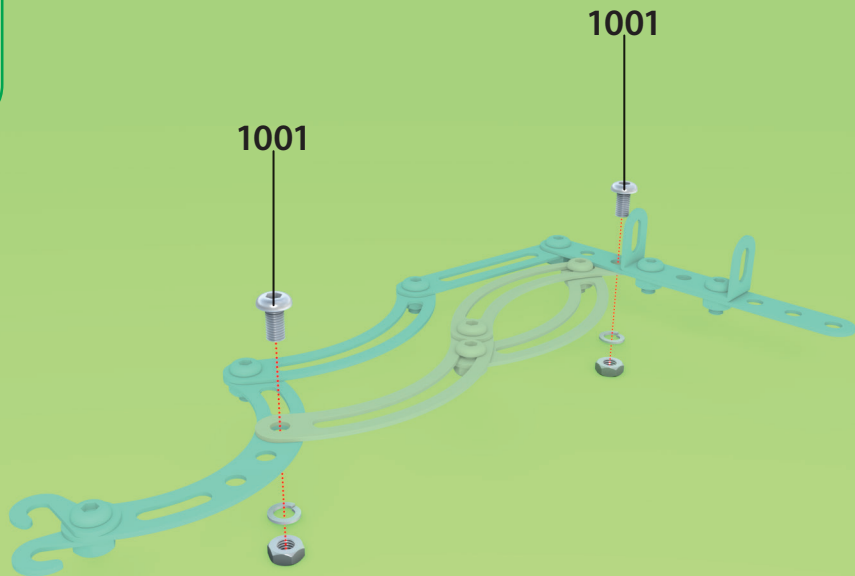

 x 2



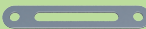

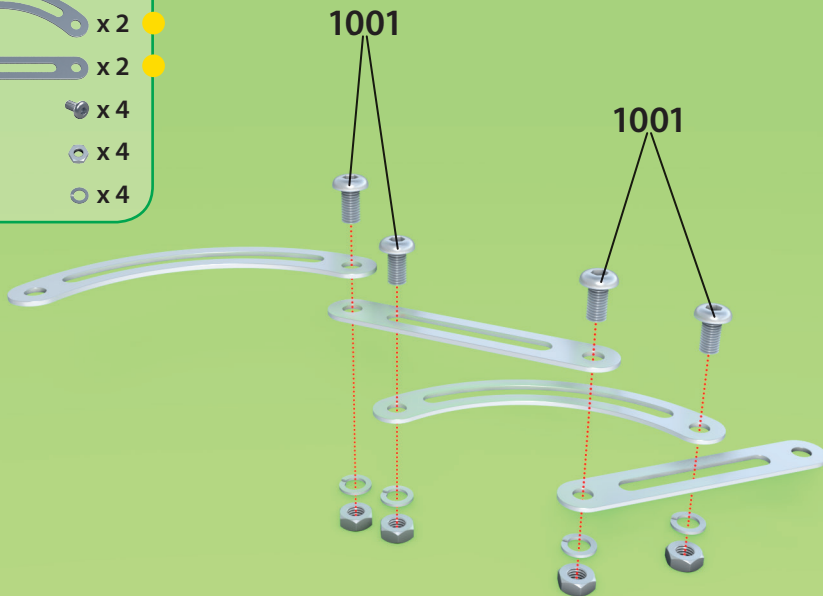

 x 2

 x 2

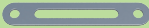

-  x 2 
-  x 2 
-  x 4
-  x 4
-  x 4



-  x 2 
-  x 2 
-  x 4
-  x 4
-  x 4

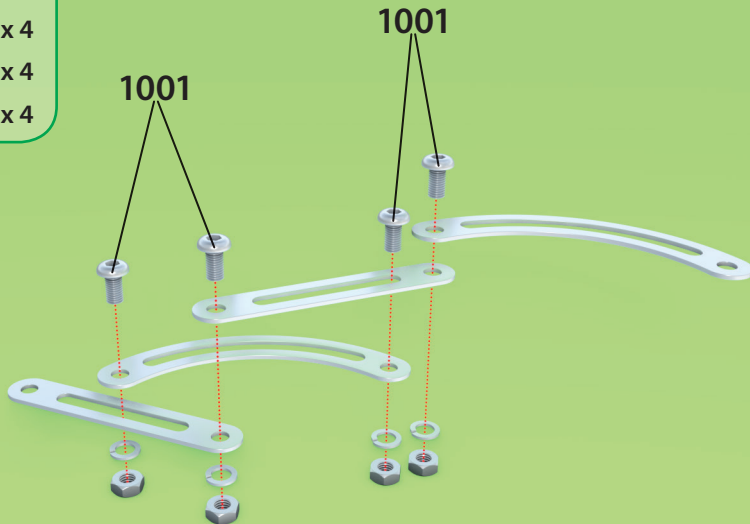

 x 2

 x 2

 x 2

1001



1001

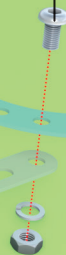

27

 x 2

 x 2

 x 2

1001

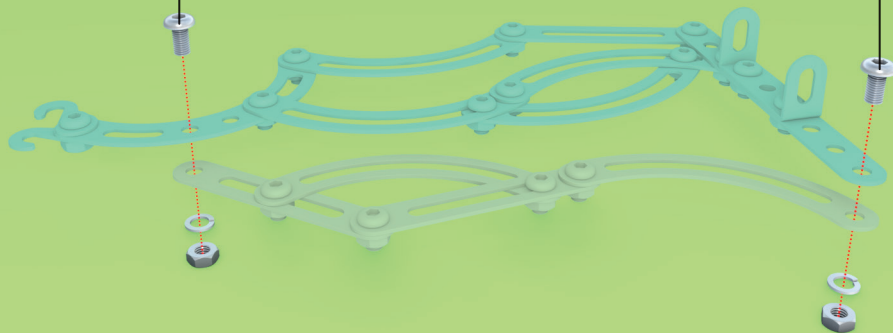

1001

 x 2

 x 2

 x 4

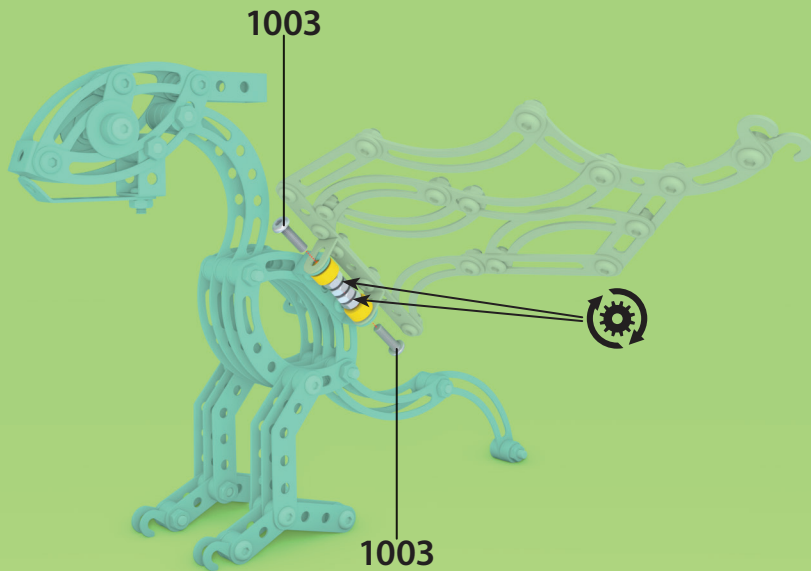

 x 2

 x 2

 x 4

